



The Next-Gen E-Invoicing Solution

PEPPOL Compliant Service Provider for the
UAE e-Invoice Mandate





01

**Strong
Foundations. Bold
Innovations.**

About Us

Marmin AI is the **technology innovation arm of AJMS Group**, created to revolutionize how businesses manage invoicing and compliance. Our **AI-driven e-invoicing platform** enables organizations to move from manual, paper-heavy processes to a **smart, automated, and compliant digital ecosystem**, helping reduce costs, speed up payment cycles, and gain real-time financial insights. **Marmin AI is already live in KSA, India, and Malaysia**, supporting enterprises in achieving seamless e-invoicing compliance.

Backed by the strength of **AJMS Group**, Marmin AI combines **cutting-edge technology** with **decades of regulatory expertise**, ensuring every solution is secure, scalable, and compliant with evolving tax and reporting frameworks.

AJMS Group is a trusted name in **Strategy, Tax, Risk, Compliance, IFRS Advisory, Distress Advisory, and Digital Transformation**. Led by **Dr. Abhishek Jajoo**, the group operates across **14 countries with nearly 700 professionals**, bringing deep industry experience as **bankers, regulators, auditors, and legal advisors**. AJMS continues to drive business transformation through innovation, compliance, and digital excellence.



AJMS Group Entities





02

Celebrating Excellence and Innovation

Excellence Acknowledged

Award-Winning E-Invoicing Experts – AJMS Group

Proud **winner of the "E-Invoicing Solution of the Year 2025"**, AJMS Group is more than a technology provider - we are **regional leaders in regulatory technology** and **trusted advisors** for tax and compliance transformation.

With a strong presence across the GCC, deep ties with the **Federal Tax Authority (FTA)**, and a **client-first approach**, we ensure your transition into the UAE's new e-invoicing era is smooth, secure, and future-ready.



Proud Moments of Success

**Superbrands
Award**



**Future 100
Award**

**Awarded "Excellence in
Finance Consulting"
Award by prestigious
FINNEXT association,
USA.**



**Signed an MOU with
Dubai Economic
Department, as their
preferred partner, for
creating awareness of
new AML law for multiple
sectors.**

**Ainsurtech's ADPT Tool
awarded IFRS 17 Solution of
the Year 6th Insuretek
Golden Shield Excellence
Awards 2022**



Trusted. Certified. Compliant.

Accreditations



Certifications



Trusted. Certified. Compliant.

Accreditations

Marmin is now included in the Ministry of Finance (MOF) Pre-Approved List of Accredited Service Providers (ASP) for UAE e-Invoicing, as reflected on the MOF website.

Pre-Approved eInvoicing Service Providers

List and Contact Details of the Ministry of Finance Pre-Approved eInvoicing Service Providers

As per Article 15 of Ministerial Decision No. 64 of 2025, On the eligibility criteria and Accreditation procedure for Service Providers under the Electronic Invoicing System, the following list sets out the pre-approved eInvoicing Service Providers in the UAE. This list is updated periodically to include newly approved Service Providers. Final Accreditation will be granted in accordance with Article 16 of Ministerial Decision No. 64 of 2025. This list is in Alphabetical Order.

| # | COMPANY NAME | COMPANY WEBSITE | CONTACT PERSON | EMAIL | PHONE NUMBER |
|---|-------------------------------|--|-------------------|--|---------------|
| 9 | Marmin AI Software Design LLC | www.marmin.ai | Sangmesh Hiremath | sh@marmin.ai | +971557658042 |

ERP Integration Experience





03

The E-Invoicing Revolution Begins

E-Invoicing in the UAE: Facts You Can't Miss

E-Invoicing is the mandatory electronic creation, exchange, and archiving of invoices in a structured format as per the UAE Federal Tax Authority (FTA) requirements.

It enables real-time reporting, compliance, and transparency across all B2B and B2G transactions.



Mandatory Rollout by FTA

Phased e-Invoicing implementation begins **July 2026**, with full compliance by **2027**

Global Alignment

Over **90** countries, including **KSA**, **India**, and **EU** nations, have adopted e-Invoicing with the **UAE** following closely

Cost Efficiency

Reduces processing costs by **up to 60%** compared to manual invoicing

Faster Payments

Businesses achieve **30–40% quicker payment cycles**, improving cash flow

Error Reduction

Automated validation cuts invoice errors and disputes by **over 70%**

Eco-Friendly

Saves paper and supports **ESG and sustainability goals**

FTA Advantage

Real-time reporting helps **reduce tax fraud and boost transparency**

Get Ready Now, Lead Tomorrow!

E-Invoicing is the mandatory electronic creation, exchange and archiving of invoices in a structured format as per the UAE Federal Tax Authority (FTA) requirements.

It enables real-time reporting, compliance, and transparency across all B2B and B2G transactions.

COMPETITIVE ADVANTAGE

Being compliant early builds trust with clients, suppliers, and regulators

REGULATORY COMPLIANCE

Regulatory Compliance – Non-compliance may lead to penalties, system rejections, or delayed payments.

BUSINESS CONTINUITY

Early readiness avoids last-minute disruptions when e-Invoicing becomes mandatory

OPERATIONAL EFFICIENCY

Automates invoice generation, reduces errors, and accelerates receivables

DATA ACCURACY

Standardized formats ensure clean records for audits and reporting



E-Invoicing Implementation Timeline

| | Appointment Service Provider | Go Live with E-invoicing | |
|---|------------------------------|---------------------------------|---|
| A Businesses with Revenue \geq AED 50m | Jul 31, 2026 | Jan 1, 2027 | Must follow onboarding & technical requirements |
| B Businesses with Revenue < AED 50m | Mar 31, 2027 | Jul 1, 2027 | Same compliance requirements |
| C Government Entities | Mar 31, 2027 | Oct 1, 2027 | Same compliance requirements |
| Business-to-Consumer (B2C) only entities | Not applicable (for now) | Excluded until further decision | Will be included later by the Ministry |

UAE E-Invoicing Penalties

| Violation | Penalty |
|---|--|
| Delay in implementing the E-Invoicing System / appointing an Accredited Service Provider | AED 5,000 per month of delay |
| Failure to issue & transmit Electronic Invoices / Credit Note within 14 days | AED 100 per invoice / Credit Note (Max AED 5,000 per month) |
| Failure to notify the Authority of a System Failure (Supplier / Recipient) within 2 business days | AED 1,000 per day of delay |
| Failure to notify the Accredited Service Provider of changes in registered data | AED 1,000 per day of delay |

UAE E-Invoicing Architecture

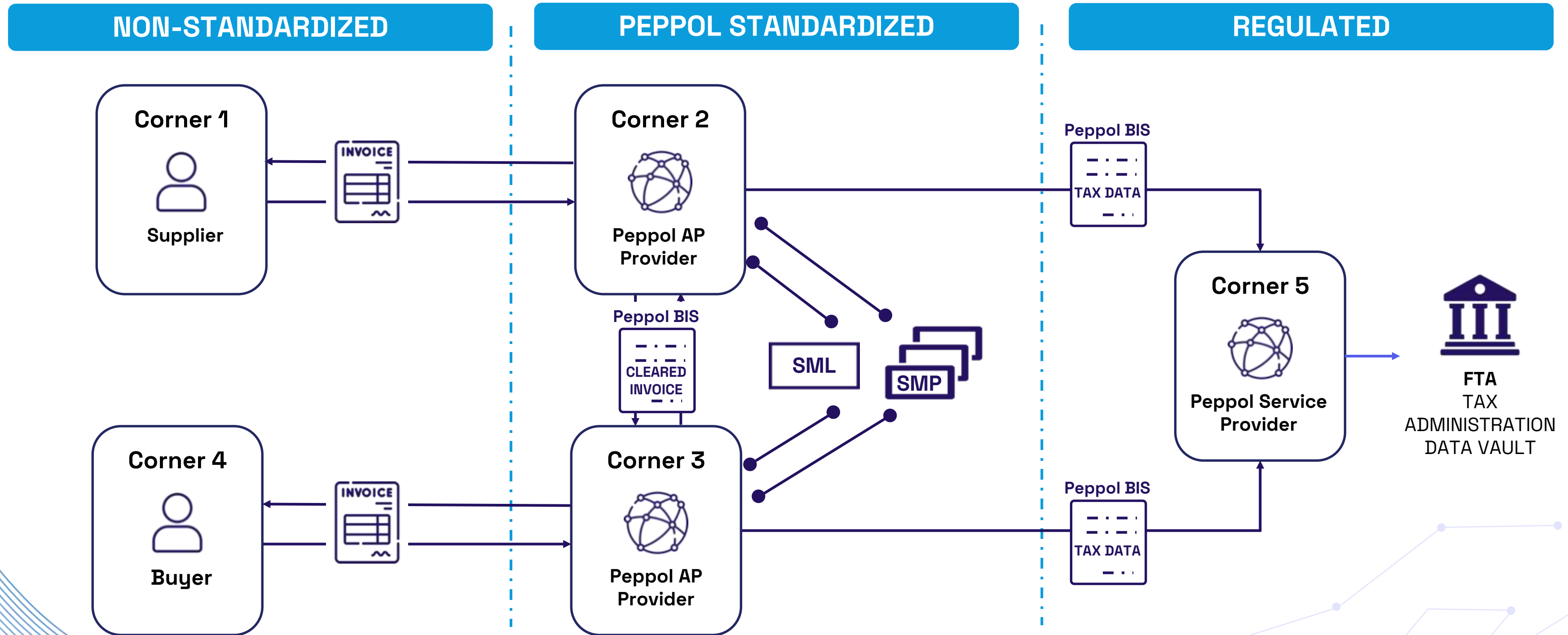

04

Unveiling Marmin AI

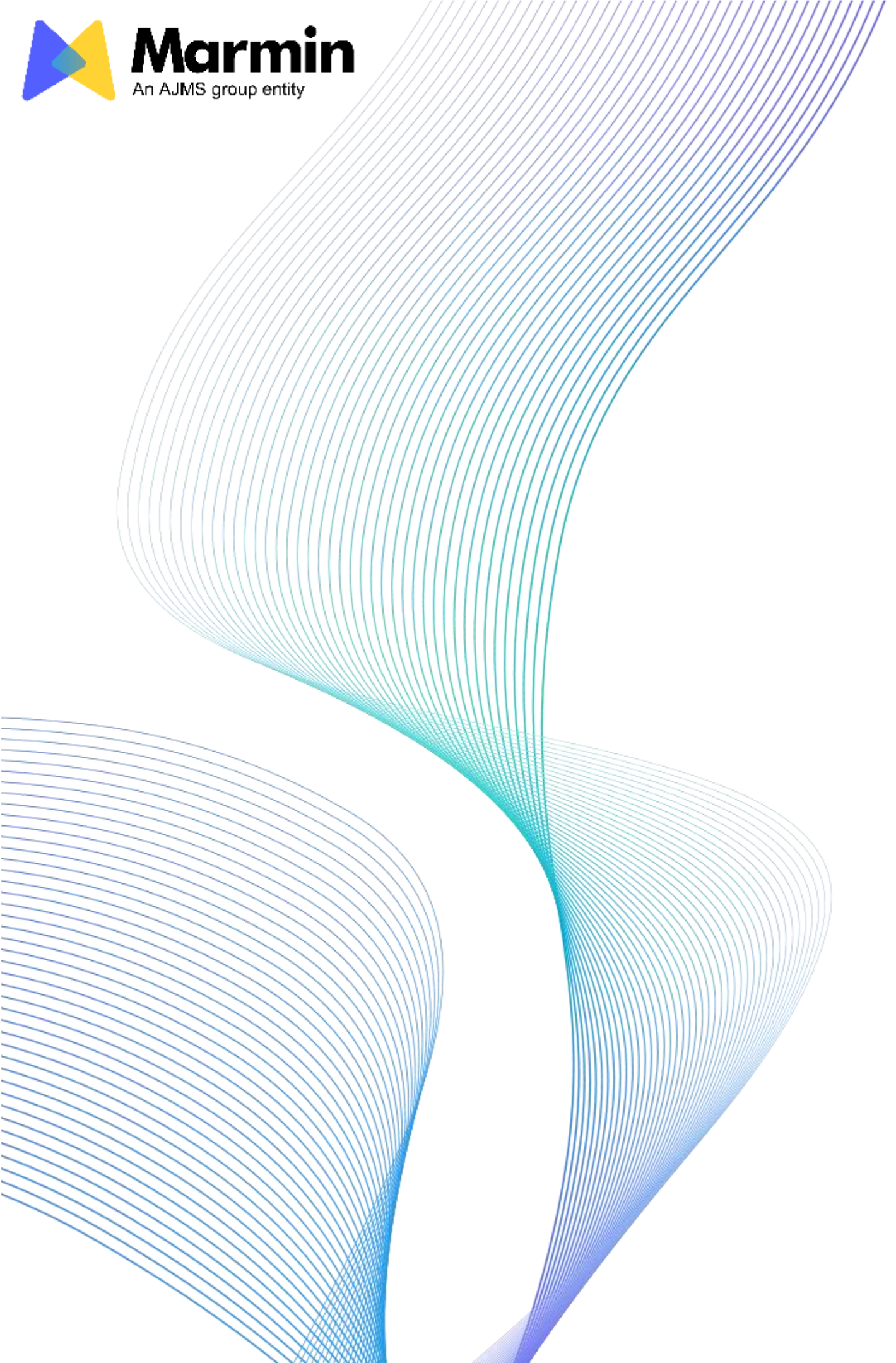

Marmin AI at a Glance

Core Offerings



A secure, scalable cloud solution built for seamless e-invoicing and compliance management.



Fully aligned with FTA (UAE) and ZATCA (KSA) frameworks, ensuring effortless compliance.

AI & Data Intelligence



Leverages advanced AI/ML for intelligent data extraction from PDFs and scanned invoices.



Minimizes manual effort through automated document classification and field mapping.



Performs over 180+ real-time data checks to ensure accuracy and compliance at every stage.

Regional & Global Readiness



Currently live across the UAE, Saudi Arabia, India, and Malaysia, delivering proven success.



Fully prepared for Oman and GCC-wide e-invoicing frameworks.



Designed to adapt effortlessly to diverse global regulatory requirements.

Advisory & Support



Expert guidance to help organizations prepare for e-invoicing mandates.



Comprehensive sessions to ensure smooth implementation and user adoption.



Continuous technical and compliance support to ensure seamless operations post-deployment.



**PEPPOL Compliant
Solution Framework**



**Global Product with
Localized Compliance**

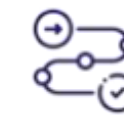

Product Roadmap

E-Invoicing Success Stories



Our E-Invoicing Solution

Efficient, Effective and Scalable

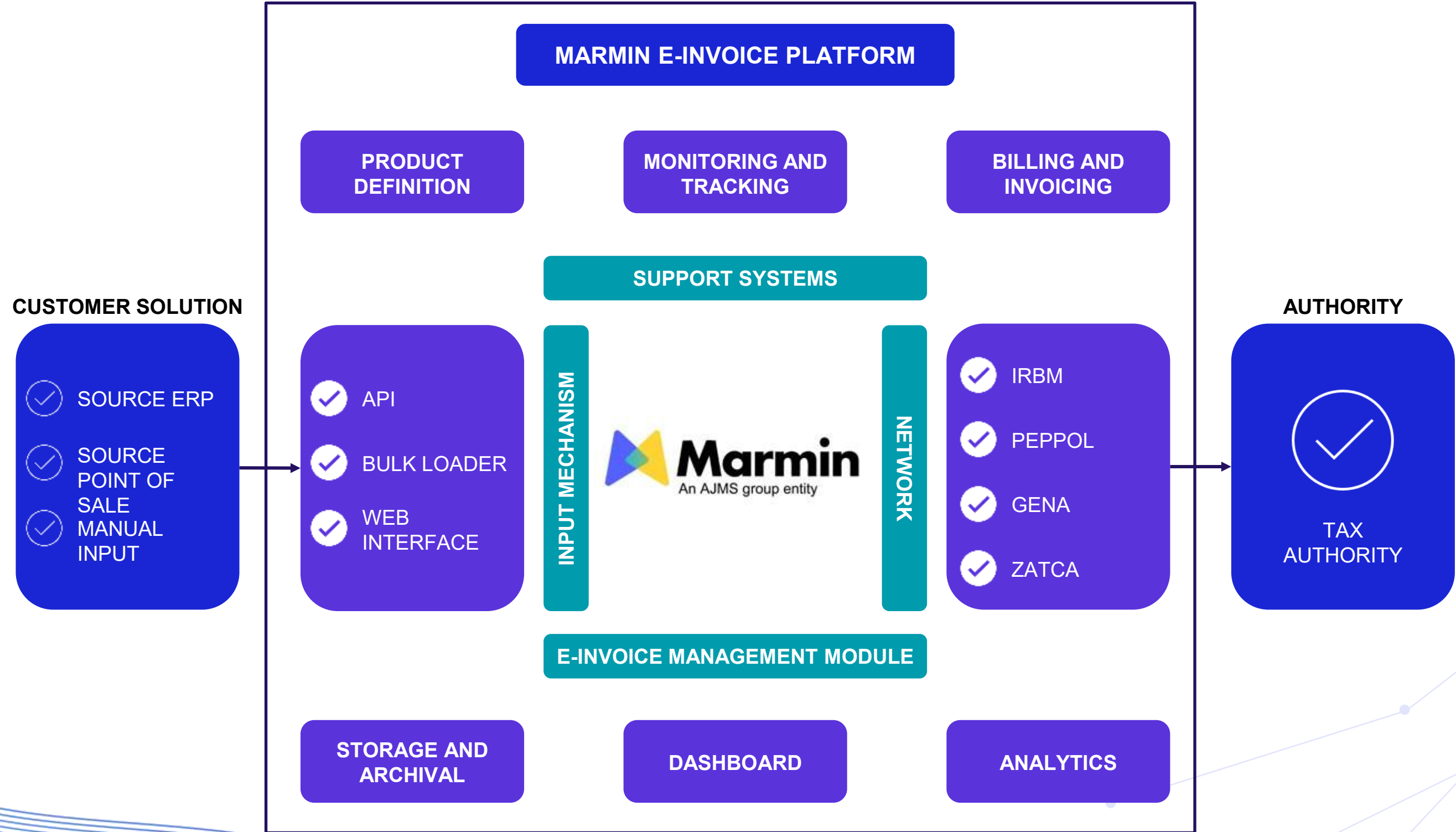

E-Invoicing Solution

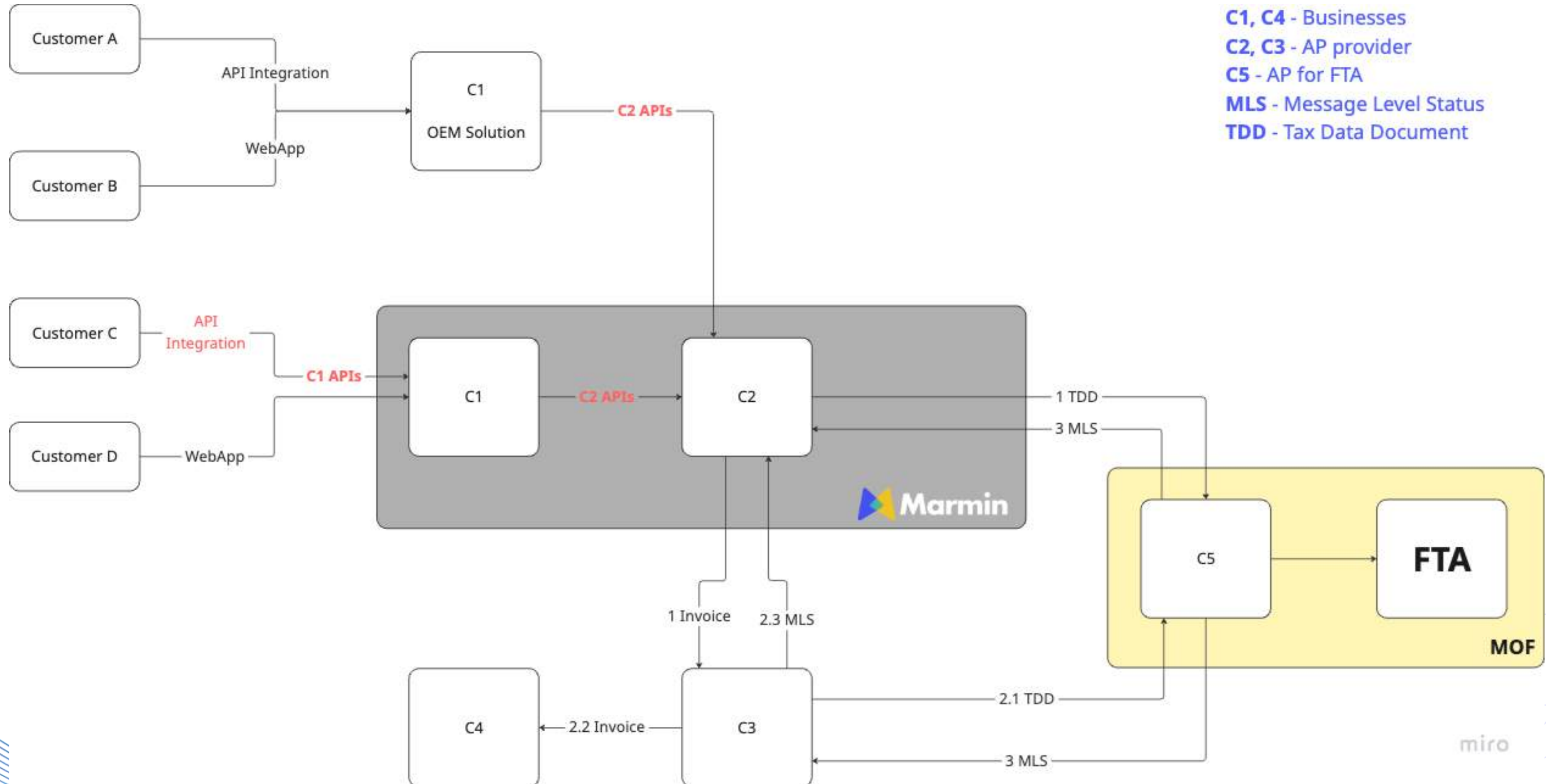

C1, C4 - Businesses
C2, C3 - AP provider
C5 - AP for FTA
MLS - Message Level Status
TDD - Tax Data Document

E-Invoicing Solution, Self-Billed Scenario

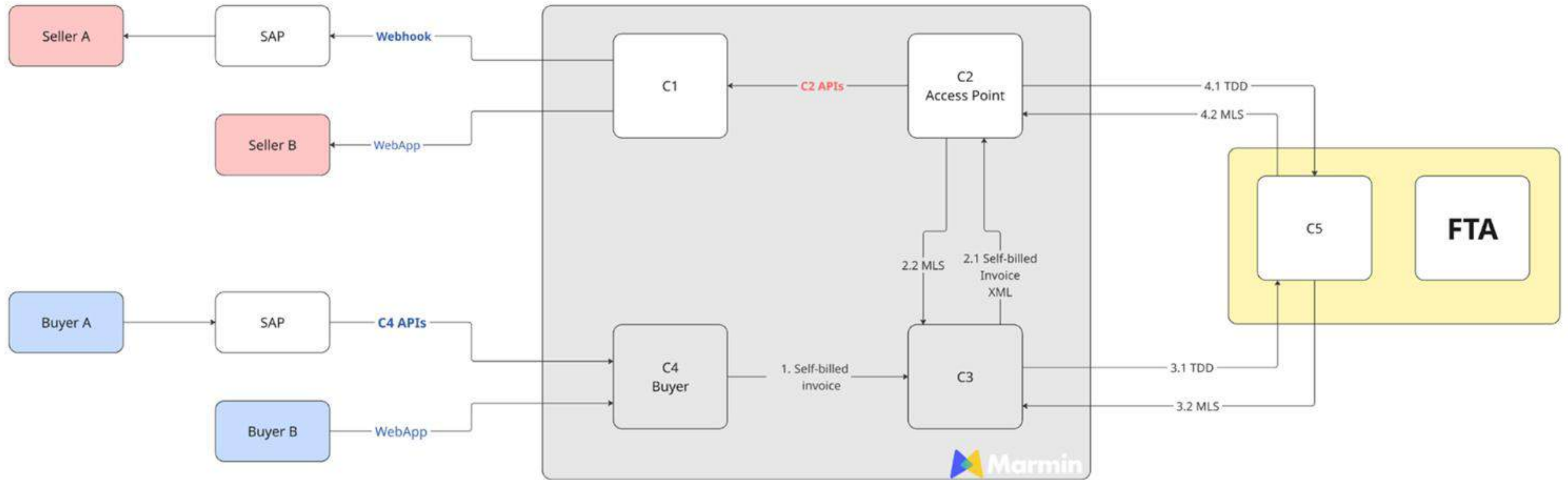

C1, C4 - Businesses
C2, C3 - AP provider
C5 - AP for FTA
MLS - Message Level Status
TDD - Tax Data Document

Empowering You with Smart Solutions

**GAP
ANALYSIS**
Impact Assessment



**IMPLEMENTATION &
TESTING**
Training & Change
Management



**ADVISORY & COMPLIANCE
ROADMAP**
System Integration



**POST-
IMPLEMENTATION
SUPPORT**



Our E-Invoicing Solution

Faster Implementation + Amazing Support



Marmin e-invoicing solution offers a smooth and easy implementation for UAE. Offers fast, dedicated support and quick implementation - often completed in just a few weeks—along with simple, user-friendly onboarding.



| Integration Method | Minimum Timeframe* | Maximum Timeframe* |
|--------------------|--------------------|--------------------|
| Web Application | 2 hours | 6 hours |
| Bulk upload | 4 hours | 2 days |
| SFTP Integration | 2 days | 5 days |
| API Integration | 5 days | 2 weeks |

*Note: These timelines represent best-case estimates. Actual duration may vary based on the number of systems to be integrated, timely availability of process owners, prompt blueprint sign-off, and stakeholder approval cycles.

Your Pathway to Seamless E-Invoicing

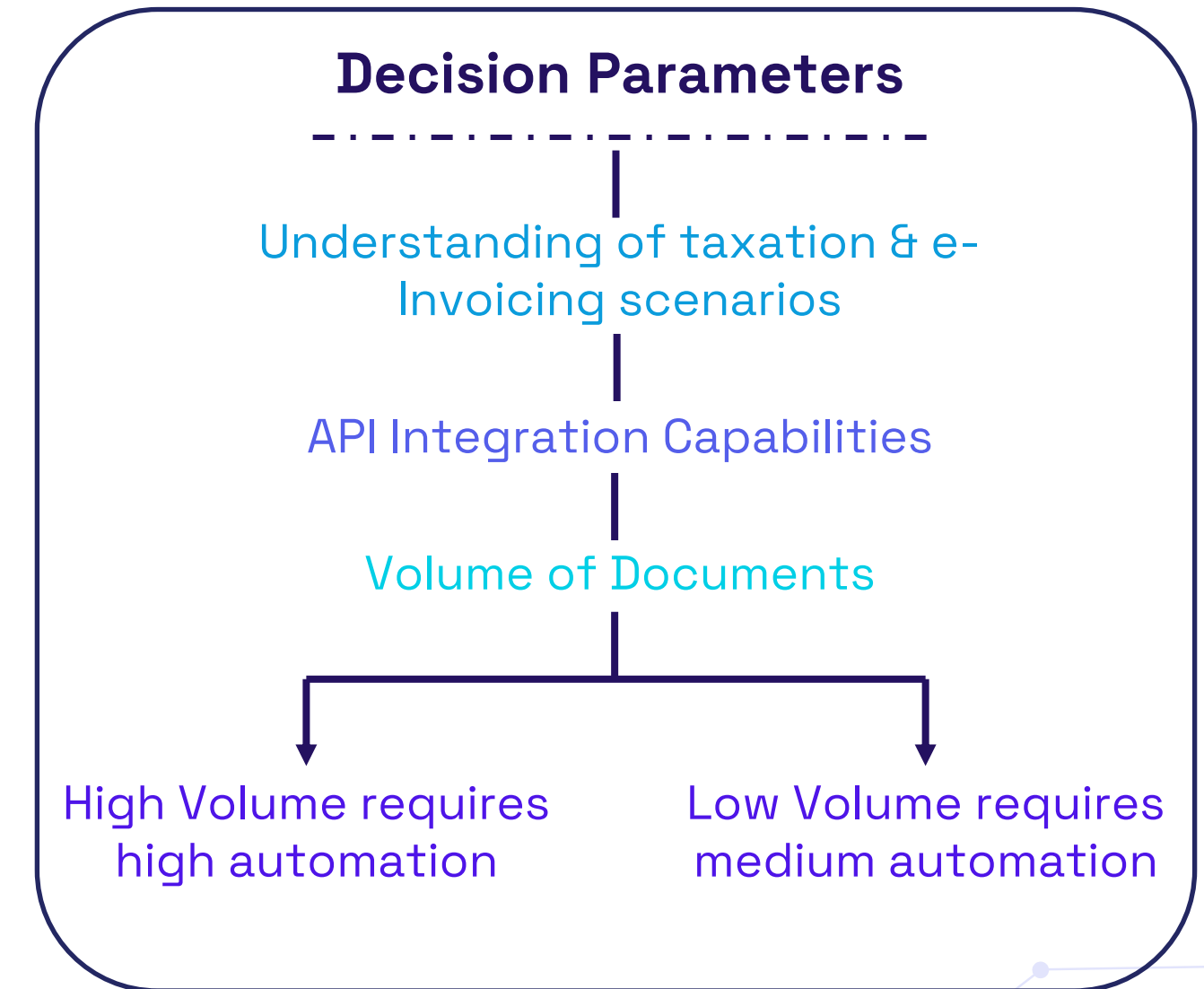
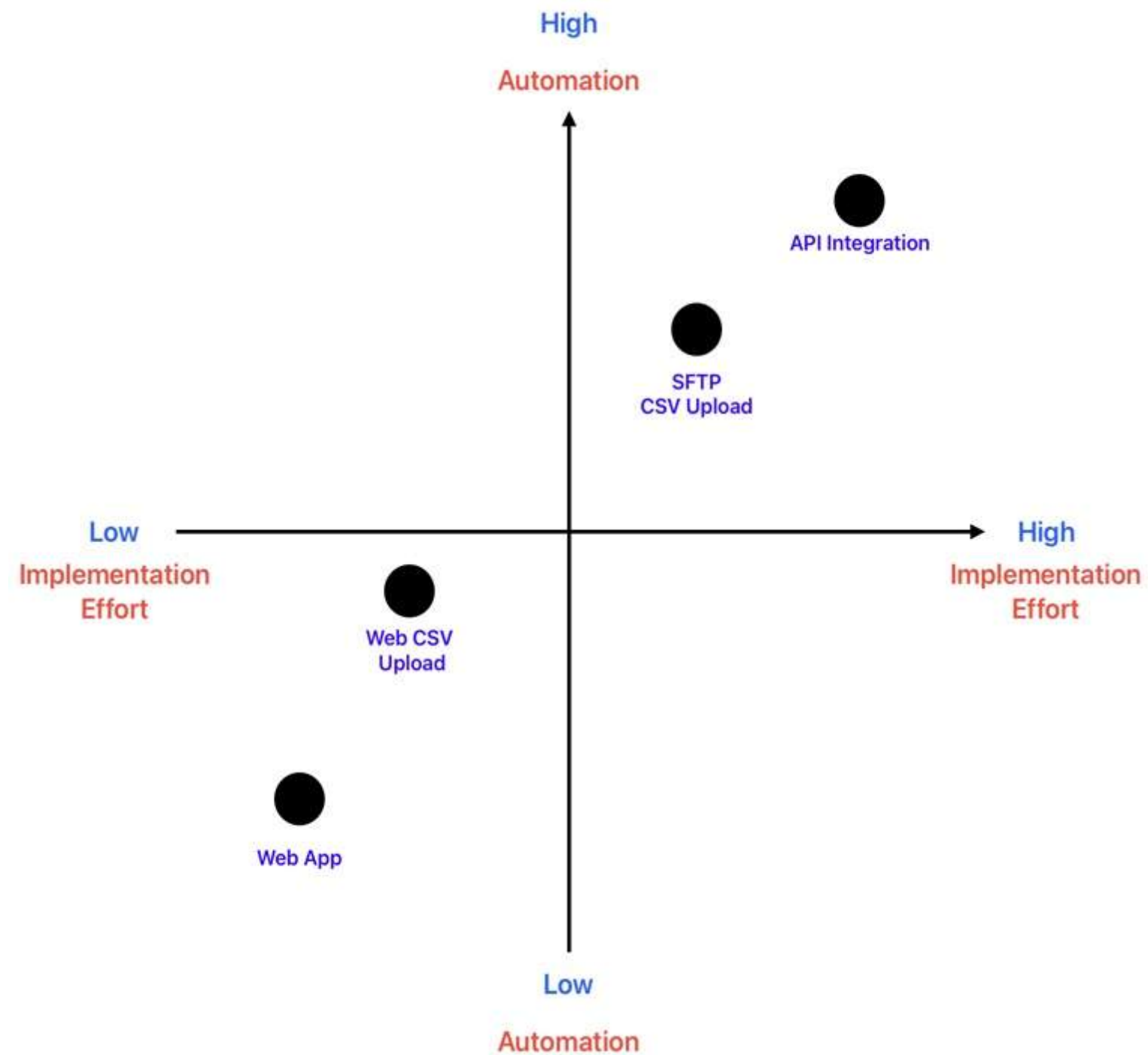

Live Demonstration

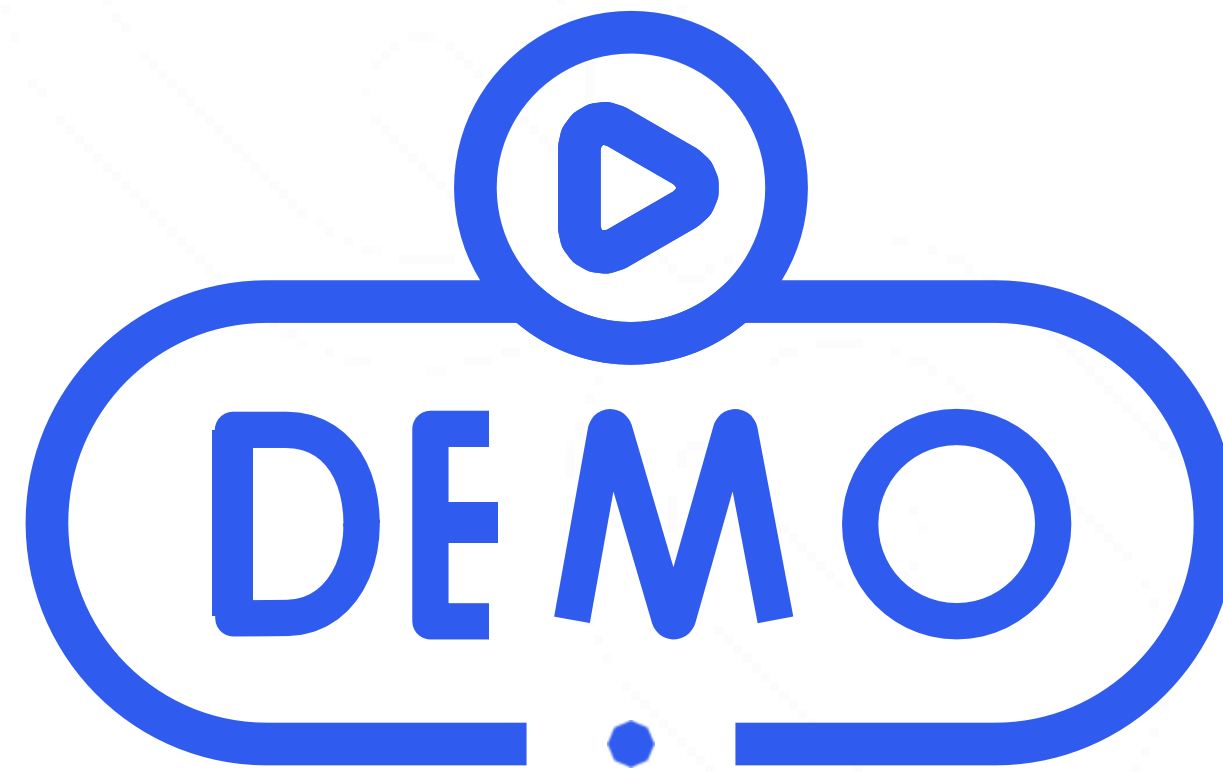



05

Our Group- wide
Growing Network
of Success Stories

Government Sector



Government of Sharjah | حكومة الشارقة | Free Zone Authority | هيئة المنطقة الحرة



Banking Sector



Insurance Sector



Finance Sector



Real Estate Sector



Money Service Business Sector



Others



DR MOOPENS
HEALTHCARE



INTERNATIONAL
APPAREL & 
TEXTILE FAIR
FASHION-FABRICS, GARMENTS, ACCESSORIES, HOME TEXTILES & MORE

ESSENTRA





06

The Innovators Behind Our Success

The People Behind the Vision



Dr. Abhishek Jajoo

Founder & Chairman

Serial entrepreneur specializing in RegTech and risk management, with deep regulatory and legal expertise



Sangmesh Hiremath

Partner – E-Invoicing

20+ years in Business Consulting, Digital Transformation and Process Automation.



Murtuza Furniturewala

Partner – E-Invoicing

22+ years of experience in Enterprise Technology and Business Transformation



Vivek Mundhra

Managing Partner

Ex-Big 4/ Dubai Govt. with expertise in Strategy & Digital Transformation



Alok Bishnoi

Partner

Ex-Big4, specialist in compliance monitoring, regulatory gap assessments, & regulatory alignment for GCC banks.



Rizwan Khan

Chief Business Officer

20+ Experience in AML/CFT Compliance.



Mirza Al Marzooq

Managing Partner - Bahrain

30+ years of experience serving a wide range of clients



Nefal Barrak

Managing Partner - KSA

Experienced Professional in Credit Analytics within Saudi Arabia

The People Behind the Vision



Satish Menon

Partner/ Process Expert

More than 30 years of financial services experience in managing various process. He headed the Banking & Governance in a leading exchange in the UAE



Rajkumar TR

Partner/ Technology Expert

25+ years of experience in developing insurance products



Bilal Aslam

Internal Audit Expert

10+ years in audit and compliance testing; designs compliance audit plans and evaluates control effectiveness



Faizan Ahmed

IT Security Expert

Ex-Big 4 with 10+ years experience in IT Security and Risk



Senthil Kumar

Technology Expert

Advised on core banking compliance monitoring and reporting for leading banks



Sunil Ravikumar

Legal & Compliance Expert

Ex-banking professional with expertise in legal compliance, corporate finance regulations, and risk advisory.



Syed Haseeb

Banking Industry Expert

Advised multiple banks across GCC on strategy, governance, and operational efficiency.

Thank You!

Do you have any questions?

E-invoicing@marmin.ai

+971 4 554 2733

<https://marmin.ai/UAE>

Head Office

206, Opal Tower, Burj
Khalifa Blvd, Business Bay,
P. O. Box : 122804, Dubai,
UAE

